

STON	2C RATING 10A 3C RATING 10A POWER RELAY	2 組接點/ 3 組接點 泛用型繼電器
------	--	--

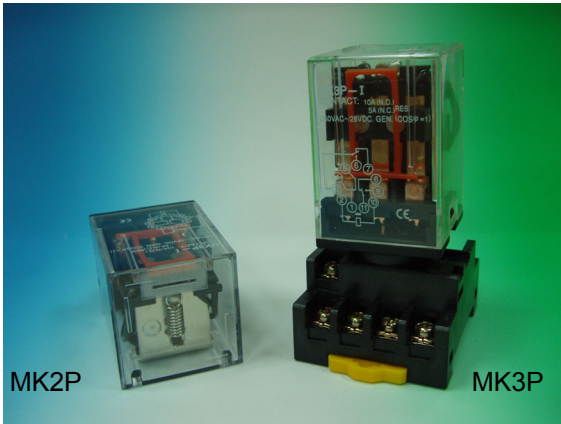

- UL , CE Approved.
- With OMRON MK relays pin to pin.
- Using PC case.
- UL , CE 認證。
- 與 OMRON MK 繼電器同腳位。
- 使用 PC 外殼。
- 具 LED 顯示。
- 輸出接點可達 2C 10A 250V / 3C 10A 250V 。

◦ **ORDERING INFORMATION 訂購說明**

Ex. MK 2 P

A220

Type 型式	Operating voltage 電壓範圍
2: MK2P 3: MK3P	D12: DC12V D24: DC24V D48: DC48V A12: AC12V A24: AC24V A110: AC110V A220: AC220V

◦ **SPECIFICATIONS & CHARACTERISTICS 規格 & 特性**

Type 型式	MK2P	MK3P
Rate operation voltage 額定電壓	DC: 12V/24V/48V AC: 12V/24V/110V/220V/240V/380V/440V	
Operating voltage range 電壓使用範圍	DC: 85%~110% AC: 80%~110%	
Rated frequency 額定頻率	AC: 50~60Hz	
Rated power consumption 額定功率消耗	About: 1VA	
Rated control capacity 輸出容量	AC:10A 250VAC P.F.=1	
Contact metal 接點材質	Ag 合金	
Reset time 復歸時間	10~20mS	
Life 壽命	Mechanical 機械 5000000	
	Electrical 電氣 100000	
Output arrangement 輸出方式	Timed-out 2 form C	Timed-out 3 form C
Max. temperature rise 最大溫升	55 deg.	
Ambient temperature 周圍溫度	-10°C to +65°C 但不結冰結露 But no ice	
Ambient humidity 周圍溼度	Max. 85% RH	
Weight 重量	About 85g	

◦ DIMENSIONS 規格尺寸

MK2P

MK3P

UNIT : mm

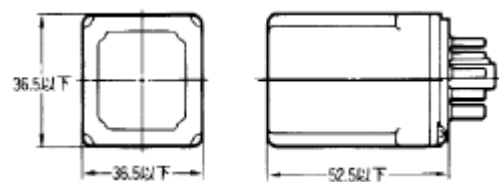
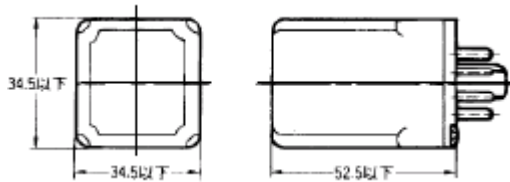

PF-083A/PF-113A

MK2P+PF-083A / MK3P+PF-113A

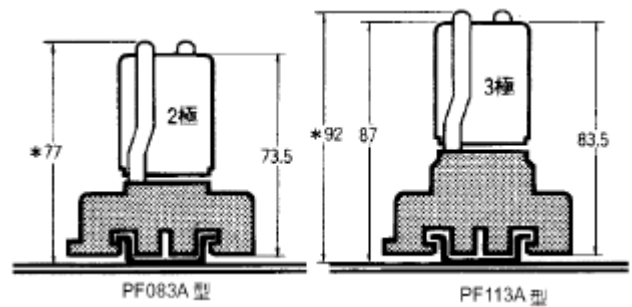
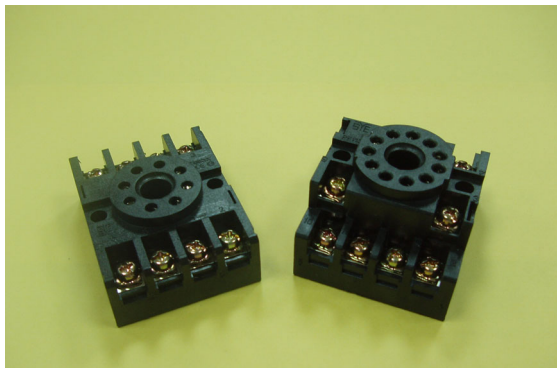

◦ OPERATION 操作方式

MK2P

MK3P

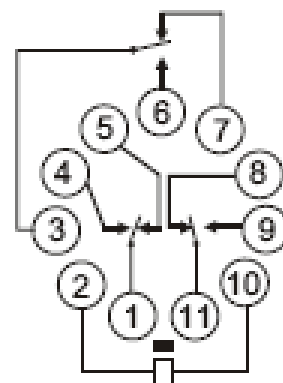
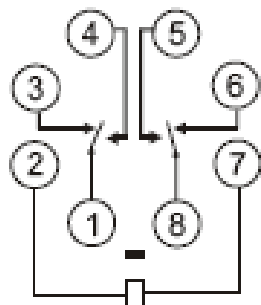

COM. : Common terminal

N.C. : Normally closed contact

N.O. : Normally open contact

○ ○ : Output contact